

Varenummer: 438000050

Beskrivelse: Rota-fix spændelement SD 50

## Mål

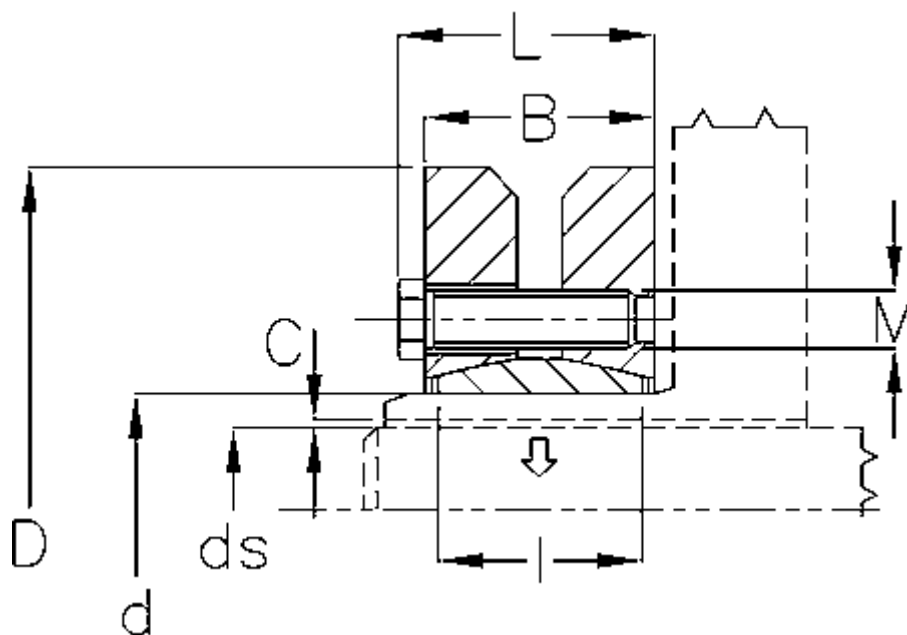

B mm	= 27
C maks.	= 0,032
d H8 mm	= 50
D mm	= 90
ds mm	= 38
F kN aksialkraft	= 79
L mm	= 31
l mm	= 22

M mm	= M6
T Nm drejningsmoment	= 940
Ts Nm boltetilspændingsmoment	= 12